

ATTO Celerity™ Gen 5 Fibre Channel Host Adapters Installation and Operation Manual

Celerity FC-162E

16Gb FC Gen 5 dual-channel PCIe 3.0 host adapter

Celerity FC-161E

16Gb FC Gen 5 single-channel PCIe 3.0 host adapter

Celerity FC-84EN

8Gb FC quad channel PCIe 2.0 host adapter

Celerity FC-82EN

8Gb FC dual channel PCIe 2.0 host adapter

Celerity FC-81EN

8Gb FC single channel PCIe 2.0 host adapter



The Power Behind the Storage

155 CrossPoint Parkway
Amherst, NY 14068

P. +1.716.691.1999
atto.com

© 2018 ATTO Technology, Inc. All rights reserved. All brand or product names are trademarks of their respective holders. No part of this manual may be reproduced in any form or by any means without the express written permission of ATTO Technology, Inc.

3/2018

PRMA-0344-000

Table of Contents

1	ATTO Celerity HBA Features & Overview.....	4
	Getting Started.....	4
	Celerity Gen 5 Fibre Channel 16Gb Adapters.....	4
	162E Technical specifications.....	4
	161E Technical specifications.....	5
	Celerity Fibre Channel 8Gb Adapters	5
	84EN Technical specifications	5
	82EN Technical specifications	6
	81EN Technical specifications	6
2	Install Drivers	9
	Downloading drivers from the ATTO website.....	9
	Windows	9
	Installing from the ATTO Technology website.....	9
	Installing from a directory containing the Celerity driver	9
	macOS.....	10
	Driver Installation (for all ATTO FC host adapters).....	10
	Installing a fresh copy of macOS onto a disk attached to a Celerity FC adapter (only for 8Gb FC adapters).....	10
	Adjusting adapter settings with the EFI Configuration Utility	10
	Installing macOS Mavericks or Mountain Lion onto a disk attached to a Celerity adapter	11
	Linux	11
	VMware ESXi 5	12
	Including driver inboot image	12
	Driver CD as an Update.....	12
	VMware ESX/ESXi 4.....	12
	Driver CD usage during ESX installation (ESX only).....	12
	Driver CD as an Update CD (ESX or ESXi)	12
	FreeBSD	13
	Specialized configurations.....	13
3	Hardware Installation	14
	System requirements.....	14
	Fibre Channel address.....	14
	Installation	14
	Bracket details.....	15
4	Updating Hardware Flash, Drivers.....	20
	Updating flash	20
	Updating drivers.....	20

Updating the ATTO Configuration Tool	20
5 Troubleshooting	22
General suggestions.....	22
macOS.....	22
Windows	22
Linux.....	23
VMware.....	23
FreeBSD	23
illumos.....	23
Supplemental Guide for VMware ESX/ESXi.....	23
Driver Configuration	23
Adapter Management.....	25
vSphere Client	25
Service Console.....	25
Windows	27
VMware ESX/EXi.....	28
Appendix A Glossary	29
Appendix B Standards, Compliances: 16Gb adapters	32
FCC standards: radio and television interference.....	32
Canadian standards.....	32
European standards.....	32
Appendix C Standards, Compliances: 8Gb adapters.....	33
FCC standards: radio and television interference.....	33
Canadian standards.....	33
European standards.....	33

1 ATTO Celerity HBA Features & Overview

The ATTO Celerity Fibre Channel family of storage products provides connectivity, intelligence and scalability.

Celerity FC host adapters simplify advanced storage networking needs such as switching, backup and data management. Specifically designed to enhance the functionality of third party fabric hardware and software, Celerity FC products are the industry-leading platform for storage connectivity.

Fibre Channel is a serial communications technology designed to transfer large amounts of data among a variety of hardware systems over long distances. It is a key technology for applications that require shared, high bandwidth access to storage.

Fibre Channel provides a logical, point-to-point, serial channel for the transfer of data between a buffer at a source device and a buffer at a destination device. It moves buffer contents from one port to another, without regard to the format or meaning of the data so different upper level protocols are able to run over Fibre Channel hardware.

The Fibre Channel architecture is structured as a hierarchical set of protocol layers. Defined within these layers are rules for signal interfaces, serial encoding and decoding, error control, frame format and communications protocols.

Getting Started

In general, to install the ATTO Celerity FC host adapter, you must:

1. Ensure you have the equipment and software you need for the installation:
 - Celerity FC adapter
 - ATTO Celerity drivers, downloaded from the ATTO website (<https://www.atto.com/>)
 - A computer with an available expansion slot
 - Storage, cables and connectors
2. Install drivers for your operating system. Refer to [Install Drivers](#).

3. Install the configuration software from the ATTO download pages.
4. Install the Celerity adapter. Refer to [Hardware Installation](#).
5. Attach storage.
6. If required, configure your Celerity adapter using the ATTO Configuration Tool.



Note

Default settings are appropriate for most systems but you may change settings using the ATTO Configuration Tool.

Celerity Gen 5 Fibre Channel 16Gb Adapters

The ATTO Celerity 16Gb HBAs leverage two next-generation storage technologies: PCIe 3.0 interconnect and 16-Gigabit Fibre Channel.

With 16 Gb FC speeds of up to 1600 MB/sec. per channel, 16Gb Celerity adapters support the most demanding application requirements, including high-definition video, rich content databases and other high-bandwidth environments.

ATTO Celerity host adapters are an integrated family of advanced storage connectivity solutions that are designed to provide reliable connectivity, intelligence and scalability.

162E Technical specifications

- Two independent Fibre Channel ports
- 16-Gigabit data transfer rates
- 3200 MB/sec. maximum full-duplex throughput per channel

- Supports all FC topologies: fabric, arbitrated loop and point-to-point
- ANSI Fibre Channel: FC-FS, FC-AL, FCP, FC-AL2, FC-PLDA, FC-FLA
- Flash ROM for easy field upgrades
- FC Class 3 support
- Local management and diagnostics
- Buffer credits: 81
- ATTO Advanced Data Streaming (ADS™) Technology
- Length: 6.600 inches
- Height: 2.731 inches
- Operating temperature and Airflow: 0-40 °C (32-104 °F) - 60lfm minimum recommended; 40-55 °C (104-132 °F) 100lfm minimum recommended
- Storage temperature: -40 to 70 °C (-40 to 158 °F)
- Relative humidity: 10 to 95% non-condensing
- RoHS compliant



161E Technical specifications

- One Fibre Channel port
- 16-Gigabit data transfer rates
- 3200 MB/sec. maximum full-duplex throughput per channel
- Supports all FC topologies: fabric, arbitrated loop and point-to-point
- ANSI Fibre Channel: FC-FS, FC-AL, FCP, FC-AL2, FC-PLDA, FC-FLA
- Flash ROM for easy field upgrades
- FC Class 3 support

- Local management and diagnostics
- Buffer credits: 81
- ATTO Advanced Data Streaming (ADS™) Technology
- Length: 6.600 inches
- Height: 2.731 inches
- Operating temperature and Airflow: 0-40 °C (32-104 °F) - 60lfm minimum recommended; 40-55 °C (104-132 °F) 100lfm minimum recommended
- Storage temperature: -40 to 70 °C (-40 to 158 °F)
- Relative humidity: 5 to 95% non-condensing
- 10.97W
- RoHS compliant

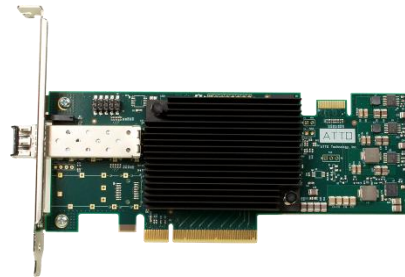

Celerity Fibre Channel 8Gb Adapters

The ATTO Celerity 8Gb HBAs leverage two next-generation storage technologies: PCIe 2.0 interconnect and 8-Gigabit Fibre Channel.

With 8-Gb FC speeds of up to 800 MB/sec. per channel, 8Gb Celerity adapters support the most demanding application requirements, including high-definition video, rich content databases and other high-bandwidth environments.

ATTO Celerity host adapters are an integrated family of advanced storage connectivity solutions that are designed to provide reliable connectivity, intelligence and scalability.

84EN Technical specifications

- Four independent Fibre Channel ports 8-Gigabit data transfer rates
- 1600 MB/sec. maximum full-duplex throughput per channel
- Supports all FC topologies: fabric, arbitrated loop and point-to-point
- ANSI Fibre Channel: FC-FS, FC-AL, FCP, FC-AL2, FC-PLDA, FC-FLA
- Flash ROM for easy field upgrades
- FC Class 3 support
- Local management and diagnostics
- Buffer credits: 41
- ATTO Advanced Data Streaming (ADS™) Technology
- Length: 6.6 inches
- Height: 3.987 inches
- Operating temperature: 0-40 °C (32-104 °F)
- Storage temperature: -40 to 70 °C (-40 to 158 °F)

- Relative humidity: 10 to 90% non-condensing
- 7.8 W (typical)
- 100 lf/m (minimum) airflow recommended
- RoHS compliant



82EN Technical specifications

- Two independent Fibre Channel ports
- 1600 MB/sec. maximum throughput per channel in full-duplex mode
- 8-Gigabit data transfer rates
- Conforms to PCI Express Low Profile form-factor specifications
- Supports all FC topologies: fabric, arbitrated loop and point-to-point
- ANSI Fibre Channel: FC-FS, FC-AL, FCP, FC-AL2, FC-PLDA, FC-FLA
- Flash ROM for easy field upgrades
- FC Class 3 support
- Local management and diagnostics
- Buffer credits: 41
- ATTO Advanced Data Streaming (ADS™) Technology
- Length: 6.6 inches
- Height: 2.731 inches
- Operating temperature: 0-40 °C (32-104 °F)
- Storage temperature: -40 to 70 °C (-40 to 158 °F)
- Relative humidity: 10 to 90% non-condensing
- 5.9W (typical)
- 100 lf/m (minimum) airflow recommended
- RoHS compliant



81EN Technical specifications

- One independent Fibre Channel port
- 8-Gigabit FC data transfer rates
- 1600 MB/sec. throughput in full-duplex mode
- Supports all FC topologies: fabric, arbitrated loop and point-to-point
- ANSI Fibre Channel: FC-FS, FC-AL, FCP, FC-AL2, FC-PLDA, FC-FLA
- Flash ROM for easy field upgrades
- FC Class 3 support
- Local management and diagnostics
- Buffer credits: 41
- ATTO Advanced Data Streaming (ADS™) Technology
- Length: 6.6 inches
- Height: 2.731 inches
- Operating temperature: 0-45°C (32-113°F)
- Storage temperature: -40 to 70°C (-40 to 158°F)
- Relative humidity: 10 to 90% non-condensing
- 5.3 W (typical)
- 100 lf/m (minimum) airflow recommended
- RoHS compliant



Selection guide: Celerity 16Gb Gen 5 adapters

Product Features	FC-162E	FC-161E
Fibre Channel Ports	2	1
FC protocol	16-Gb	16-Gb
Maximum Transfer Rate (full duplex)	3200 MB/sec	1600 MB/sec.
Bus type	PCIe 3.0	PCIe 3.0
Bus characteristics	8 lane	8 lane
Optical interface	SFP+ LC	SFP+ LC
Maximum cable length (OM2 type cable)	50m@8-Gb 35m@16-Gb	50m@8-Gb 35m@16-Gb
Low profile form factor	✓	✓
Advanced Data Streaming (ADS™) Technology	✓	✓
Developer's kit (Target Mode & API)	✓	✓
Windows support	✓	✓
Linux driver support	✓	✓
Macintosh macOS driver support	✓	✓
FreeBSD driver support	✓	✓
VMware ESXi Server 6.0, 5.5 and 5.1	✓	✓
Windows Hyper-V	✓	✓

Selection guide: Celerity 8Gb adapters

Product Features	FC-84EN	FC-82EN	FC-81EN
Fibre Channel Ports	4	2	1
FC protocol	8-Gb	8-Gb	8-Gb
Maximum Transfer Rate (half duplex)	3.2 GB/sec	1.6 GB/sec	800 MB/sec.
Maximum Transfer Rate (full duplex)	6.4 GB/sec	3.2 GB/sec	1.6 GB/sec.
Bus type	PCIe 2.0	PCIe 2.0	PCIe 2.0
Bus characteristics	8 lane	8 lane	4 lane
Optical interface	SFP+ LC	SFP+ LC	SFP+ LC
Maximum cable length	300m@2-Gb 150m@4-Gb 50m@8-Gb	300m@2-Gb 150m@4-Gb 50m@8-Gb	300m@2-Gb 150m@4-Gb 50m@8-Gb
Low profile form factor		✓	✓
Advanced Data Streaming (ADS™) Technology	✓	✓	✓
Developer's kit (Target Mode & API)	✓	✓	✓
Windows support	✓	✓	✓
Linux driver support	✓	✓	✓
Macintosh macOS driver support	✓	✓	✓
VMware ESXi Server 5.x	✓	✓	✓
VMware ESX/ESXi Server 4.x	✓	✓	✓
VMware ESX Server 3.5	✓	✓	✓
Windows Hyper-V	✓	✓	✓
1 ATTO Express Power Center recommended			

2 Install Drivers

Before installing your Celerity adapter, you must configure your system to recognize and use it by installing drivers for your operating system.

Your adapter was properly flashed before shipment. However, you must add Celerity drivers to your computer before continuing with installation.

If you already have one or more Celerity adapters installed and you have the latest drivers found on the ATTO website, or you followed the instructions in the Getting Started Guide, you do not need to perform any of these procedures.

Drivers are provided on the ATTO website at <http://www.atto.com/downloads.php>. Log in, if previously registered, or register to proceed to the download pages. Once downloaded, continue with the driver installation procedures (below) for your operating system.

Downloading drivers from the ATTO website

Use this procedure if you need to update drivers. The latest driver for your adapters can be found on the ATTO website.

1. Go to www.atto.com.
2. On the home page menu, put your cursor over SUPPORT then click on Downloads.
3. Register or log in if previously registered.
4. Select Fibre Channel HBAs from the product list.
5. Select your model.
6. From the table, find your Operating System.
7. Click on the entry for the latest driver.

8. A download window appears. Follow the instructions for downloading the driver.
 - Internet Explorer users may select Run to automatically run the downloaded self-extracting executable file.
 - All other browser users select a download destination and run the self-extracting executable file.
9. Continue with the driver installation as described on the following pages for your Operating System.

Windows

Installing from the ATTO Technology website

1. Power on your system.
2. Log on to Windows as the system administrator.
3. Locate the ATTO driver on your system and click unzip. The driver files are extracted and the driver installer is launched.
4. If you have User Account Control enabled, you are asked for permission for the installer to continue. If you do not have administrator privileges, you are also asked for an administrator user name and password. Fulfill the required fields and click Continue.
5. Click Install.
6. Follow the on-screen instructions to complete the driver installation.
7. Continue on to [Install Hardware](#).

Installing from a directory containing the Celerity driver

1. Power on your system.
2. Log on as the system administrator.
3. Navigate to the directory containing the Celerity driver.
4. Run Setup.exe.
5. Click Install.
6. If you have User Account Control enabled, you are asked for permission for the installer to continue. If you do not have administrator privileges, you are also asked for an administrator user name and password. Fulfill the required fields and click Continue.
7. Follow the on-screen instructions to complete the installation.
8. Continue on to [Install Hardware](#).

macOS

 **Note** *Some ATTO Celerity FC drivers are included on the macOS (10.8.x and later) Distribution CD and do not require additional installation steps, however we recommend you visit the ATTO website to check for, and download, the latest drivers and firmware.*

 **Note** *The ATTO Celerity FC host adapters (except for FC-164E) support macOS operating systems. ATTO 16Gb and 8Gb FC adapters also have EFI boot support on Intel based systems.*

Driver Installation (for all ATTO FC host adapters)

9. Power on your system.
10. Double-click the downloaded driver file to launch the installer
11. Follow the on-screen instructions.
12. Continue on to [Install Hardware](#).
13. Launch

Installing a fresh copy of macOS onto a disk attached to a Celerity FC adapter (only for 8Gb FC adapters)

 **Note** *Boot support is available on Intel-based systems only.*

 **Note** *The EFI boot driver is disabled by default. To enable it, use the ATTO Configuration Tool in an existing macOS installation, or use the EFI Configuration utility built into the EFI driver (see the procedure below for launching the utility).*

 **Note** *This is a two-step process. First step is to adjust adapter settings with the EFI Configuration utility. Second step is to install the macOS onto a disk attached to the adapter. Please review thoroughly to ensure you are using the second step corresponding to the macOS version available in your system.*

Adjusting adapter settings with the EFI Configuration Utility

 **Note** *Depending on your configuration, it may be necessary to adjust adapter NVRAM settings prior to performing the macOS installation. For example, you may need to modify the connection mode or data rate. The EFI configuration utility can be launched from the EFI shell.*

 **Note** *An EFI shell is not included with Intel Macs. ATTO recommends rEFIt, which is available for free from <http://refit.sourceforge.net>. Once you have downloaded the DMG or rEFIt, follow these steps to open the EFI Configuration Utility.*

1. Burn the rEFIt DMG file to a CD. Do not remove the CD.

2. Shut down the system and install the Celerity adapter
3. With the rEFIt CD inserted, boot the system while pressing and holding 'C' key. This will boot the rEFIt CD.
4. The rEFIt boot menu will appear which contains a series of icons. Release the 'C' key and use the arrows to highlight the "Start EFI Shell" icon. Press 'Return' to access the EFI Shell.
5. At the prompt, enter the 'driver-b' command. Scroll through the list of installed EFI drivers and find the ATTO Celerity driver. There may be more than one entry based on the number and type of adapter(s). Note the two or three digit hexadecimal driver handle on the far left of the screen.
6. At the prompt, enter 'drvcfg -s {handle}' where {handle} is the hexadecimal number from the previous step. This will launch the EFI Configuration Utility for the associated adapter.
7. Use the on-screen menus to configure your adapter. Help is available at the bottom of the screen.
8. When exiting the configuration utility, if you changed any settings, the system will restart the adapter so the new settings take effect.
9. At the prompt, enter 'exit' to return to the rEFIt boot menu or 'reset' to restart the system.

Installing macOS Mavericks or Mountain Lion onto a disk attached to a Celerity adapter

Models: 162E, 161E, 84EN, 82EN, 81EN

1. Install your Celerity adapter and connect your storage.
2. If you are launching the macOS installation by booting the installation DVD:
3. Launch the installation and proceed to the "Select the disk where you want to install macOS" screen
4. If you need to partition your disk, open Disk Utility from the Utilities menu. Once you partition your disk and exit, the newly created volume will appear in the installer window.
5. If you are launching the macOS installation from an existing macOS installation:
 - a. If you need to partition disk, open Disk Utility from /Applications/Utilities. Partition your disk and exit.
 - b. Launch the installation DVD and proceed to the "Select the disk where you want to install macOS" screen.
6. Select the volume on the disk where you want to install macOS.
7. Click 'Install' and proceed with the rest of macOS installation.
8. When macOS installation completes, install the latest Celerity driver from the [ATTO Technology website](#).

Linux



Note

Newer PCs may ship with UEFI firmware with Secure Boot enabled. With Secure Boot the operating system boot loaders, Linux kernel, and all kernel modules must be signed with a private key and authenticated with a corresponding public key.

When trying to load an unsigned ATTO driver on a secure boot system, you will see the following error: *modprobe: ERROR: could not insert '<driver-name>': Required key not available*

Refer to the Linux driver read me file (readme.html) contained in the driver bundle for instructions on signing and authenticating your ATTO Linux drivers.

1. Power on your system.
2. Log in as root.
3. Verify that the kernel header files, usually included with the Linux kernel development package, are installed.
4. Locate the downloaded driver and copy the driver file to a directory such as /usr/src
5. Open a Terminal session and change to the directory where you stored the driver.
6. Open your File Browser and browse to /mnt/cdrom/Linux/Drivers.
7. Click on the driver
8. Copy the driver file to a directory such as /usr/src.
9. Open a Terminal session.
10. Change to the directory where you stored the driver.
11. Extract the driver source
12. Navigate to that directory.
13. Compile and install the driver using ./install.sh. The driver is now installed and ready to use.
14. Continue on to [Install Hardware](#).

VMware ESXi 5

Including driver inboot image



Note **8Gb and 16Gb Celerity support.**

VMware vSphere 5 includes the ability to dynamically construct boot images for your ESXi 5 servers using vCenter 5. This allows you to include ATTO drivers as part of a boot image, then using PXE boot you can start an ESXi 5 host with that image. The end result is that your server(s) will boot and have ATTO drivers included without any additional steps. Consult the VMware vSphere 5 documentation for more information on this feature.

Driver CD as an Update

Adding an ATTO adapter and installing the driver after you have installed ESXi 5

1. Download the Driver Bundle, from the VMware or ATTO website, for the appropriate ATTO adapter. Unzip the contents of the bundle on your local workstation.

VMware ESX/ESXi 4

Driver CD usage during ESX installation (ESX only)



Note **8Gb Celerity support only.**

During ESX 4.x installation, you may choose to install additional drivers. This will allow you to install ESX onto storage that is attached to your ATTO adapter. You will need to write the appropriate ATTO driver ISO image to CD media.

1. During ESX installation, select Yes to install custom drivers and chose Add.
2. The installer will prompt you to insert the media containing the ATTO device driver.
3. After you add the ATTO driver, the installer will prompt you to reinsert the ESX installation media and continue with the installation.
4. When the installer prompts you to choose the location for the ESX install, you may choose local storage or storage that is attached to your ATTO adapter.

Driver CD as an Update CD (ESX or ESXi)

Adding an ATTO adapter and installing the driver after you have installed ESX/ESXi 4

1. Mount the Driver CD ISO on your local workstation.

This may require the use of a third-party ISO reader. Microsoft Windows Vista and later include a built-in ISO

reader. On Linux, use the mount command and the loopback interface. For example: **# mkdir -p /mnt/cdrom**

2. Use the Datastore Browser in the vSphere Client to upload the VIB file to your ESXi host.



Note **Alternatively, you can utilize programs like WinSCP (Windows) or SCP (Linux) to upload the file directly to your ESX host.**

3. Log in to the ESXi host on the Local Tech Support Console (ESXi), or through an SSH client.
4. Install the VIB using the following command on the ESXi host: **# esxcli software install -v <full path to VIB file>**
5. Once the VIB is installed, reboot the ESXi host.



Note **For detailed instructions or driver parameters, please reference the [Supplemental Guide for VMware ESX/ESXi](#).**

mount -r -l loop <path to driver ISO> /mnt/cdrom

2. Copy the offline bundle from the ISO image to a local folder on your workstation. This ZIP file is located in the offline-bundle folder of the ISO image (ex. offline-bundle/celerity8fc.zip).
3. Use the Datastore Browser in the vSphere Client to upload the ZIP file to your ESX/ESXi host.



Note **Alternatively, you can utilize programs like WinSCP (Windows) or SCP (Linux) to upload the file directly to your ESX host.**

4. Log in to the ESX/ESXi host on the Service Console (ESX) or the Local Tech Support Console (ESXi), or through an SSH client.
5. Install the offline bundle using the following command on the ESX/ESXi host: **# esxupdate --maintenancemode --nosigcheck update--bundle <path to driver bundle ZIP file>**
6. Once the package is installed, reboot the ESX/ESXi host.

For detailed instructions or driver parameters, please reference the [Supplemental Guide for VMware ESX/ESXi](#).

FreeBSD



Note

FreeBSD (9.1 or later) is supported on Celerity Gen 6 Celerity adapters.

1. Power on your system.
2. Login as root using the “su” command. You will be prompted to enter root’s password.
3. Verify the kernel header files are installed.
4. Locate the downloaded driver tarball and copy it to a directory such as /usr/src/. Make sure that none of the directories in the path have any spaces in their names.
5. Change to the directory where you stored the driver
cd /usr/src
6. Extract the files from the driver tarball by executing the following command, where XXX is the driver’s version number:

```
tar xvf fbsd_drv_cltryfc16_XXX.tgz
```

7. The driver files are extracted to a directory called fbsd_drv_cltryfc16_XXX where XXX is the driver’s version number.
8. Change to the directory created by the tar command as follows, where XXX is the driver’s version number:
cd fbsd_drv_cltryfc16_XXX
9. Compile and install the driver by executing the install script as follows:
./install.sh
10. You will be prompted a number of times to provide the installer with your installation options. Answer each of the questions until the installation is complete.
11. Continue on to [Install Hardware](#)

Specialized configurations

Some specialized applications may benefit from modification of adapter settings. The ATTO Utilities Installation and Operation Manual provides detailed

information on using ATTO Technology configuration utilities found on the Installation CD or downloaded from the [ATTO website](#).

3 Hardware Installation

You need a basic understanding of Fibre Channel before installing the Celerity FC host adapter. Please refer to Appendix A for a list of related websites.

 **CAUTION** *Back up your system data before changing or installing any hardware.*

System requirements

For Celerity FC-164E only, external power cables are also included. Please contact your ATTO authorized sales representative if any items are missing.

To install and use the Celerity Fibre Channel host adapter you need:

- A computer with an available PCI Express expansion slot
- The complete Celerity FC host adapter package

Fibre Channel address

Celerity FC adapters are configured with a unique address designated by the Institute of Electrical and Electronic Engineers. The WorldWide Port Name (WWN) and Node Name are the two components of the address assigned to Fibre Channel products. This address, stored in flash memory, allows the system to recognize the Celerity host adapter as a unique part of your configuration. The address is clearly marked on the back of the board for easy identification. Please keep a reference copy of the number in a safe place or write in the space provided on this page.

Celerity FC host adapter WWNs are assigned for each channel. The WWN listed on your host adapter is assigned to

the first channel (1). Sequential WWNs apply for additional channels.

apply for additional channels.

WWN 1:	all adapters
WWN 2:	82EN, 84EN, 162E, 164E
WWN 3:	84EN, 164E
WWN 4:	84EN, 164E

Installation

 **CAUTION** *Celerity FC host adapters contain components that are sensitive to electrostatic discharge (ESD). ESD can cause damage to the Celerity FC host adapter. Please follow standard methods to avoid ESD.*

1. Install the latest drivers. Refer to [Install Drivers](#).
2. Power down the computer and unplug the computer from all power sources.
3. Open the case.
4. Install the Celerity FC host adapter in any open PCI Express expansion slot. For Celerity FC-164E only, install the appropriate external power cable (supplied). If you have questions about how to install an expansion card in your system, consult your computer's documentation

Bracket details

Exhibit 1 FC-162E

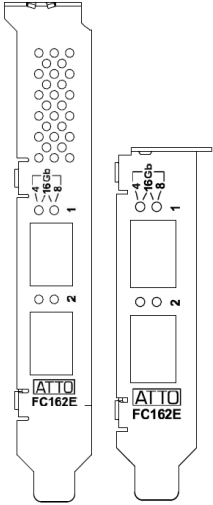

Exhibit 3 FC-84EN

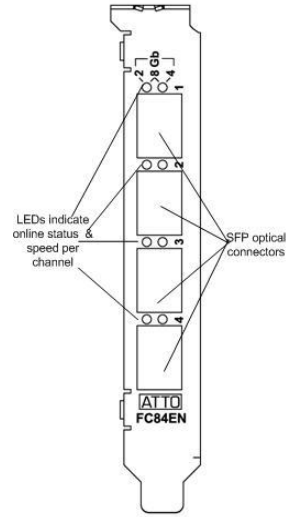

Exhibit 2 FC-161E

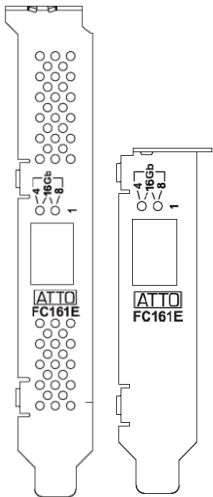

Exhibit 4 FC-82EN full height and low profile

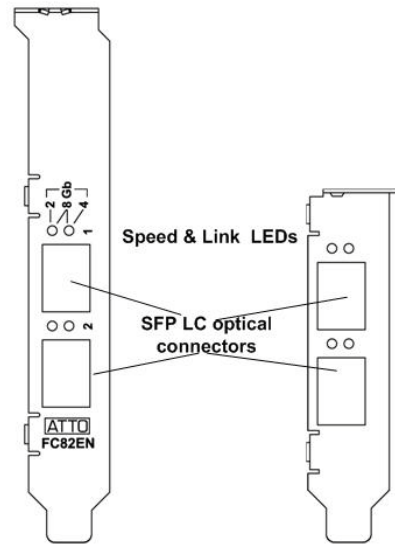
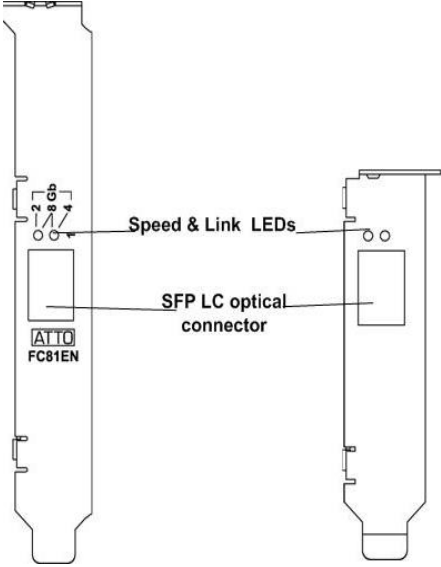

Exhibit 5 FC-81EN full height and low profile



Adapter board details

CAUTION Celerity 16Gb Quad Fibre Channel Host Adapters (FC-164E) require external power supply and adequate cooling to ensure proper system operation and prevent data loss.

1. Connect Fibre Channel devices by inserting a Fibre Channel cable from the devices to the connectors on the Celerity FC host adapter until you hear a click.
2. Close the case on the computer and power it up.

Exhibit 6 FC-164E

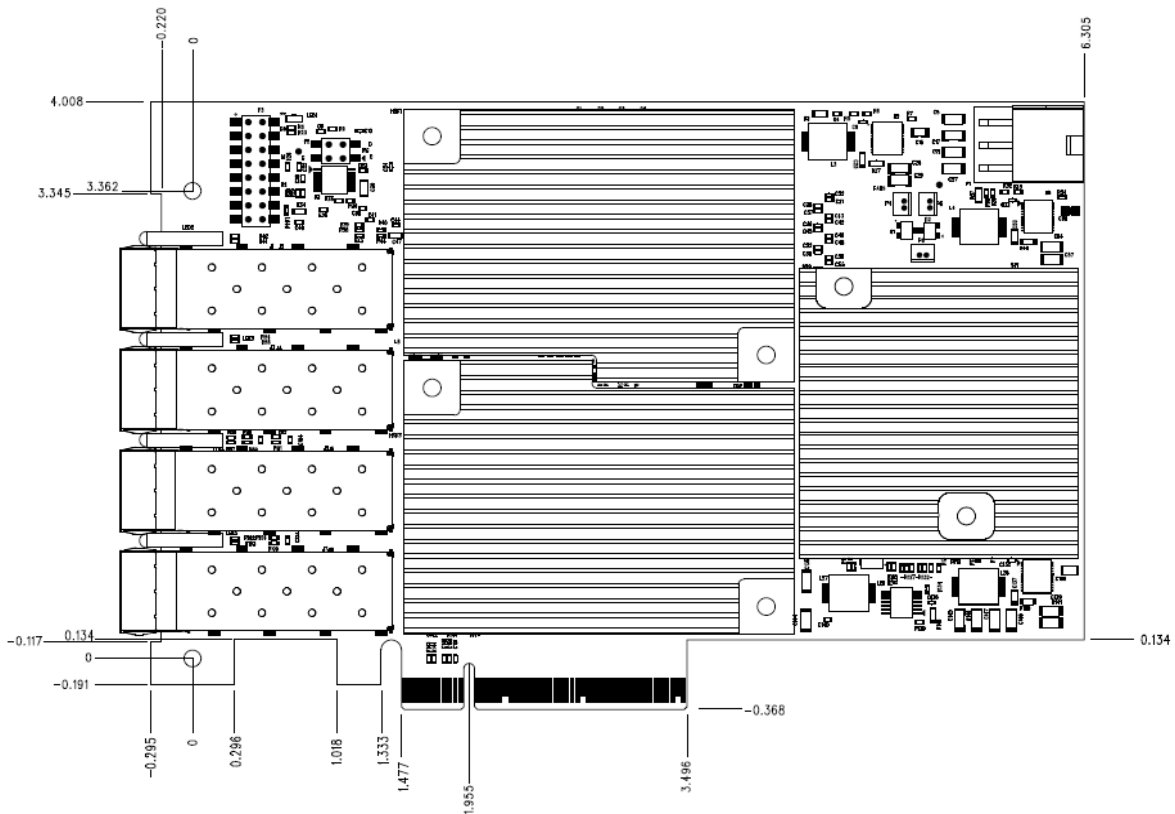

Exhibit 7 FC-162E

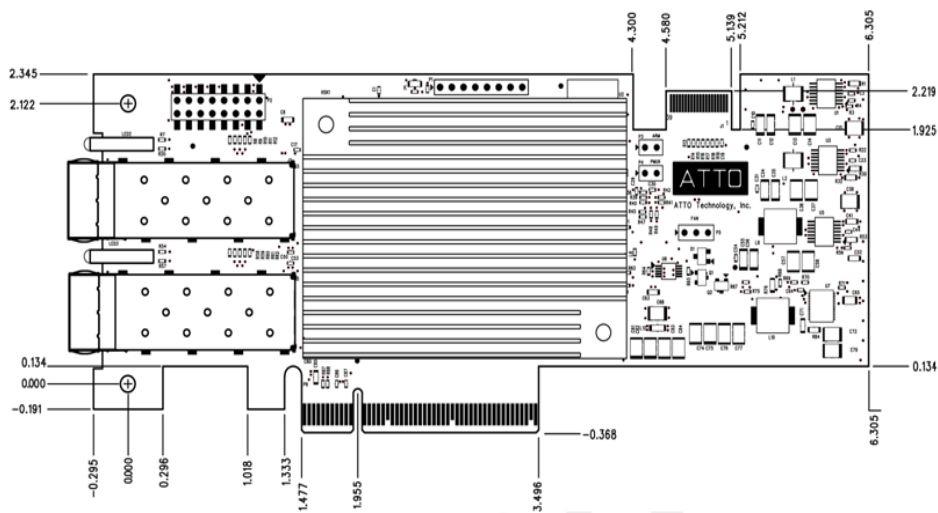

Exhibit 8 FC-161E

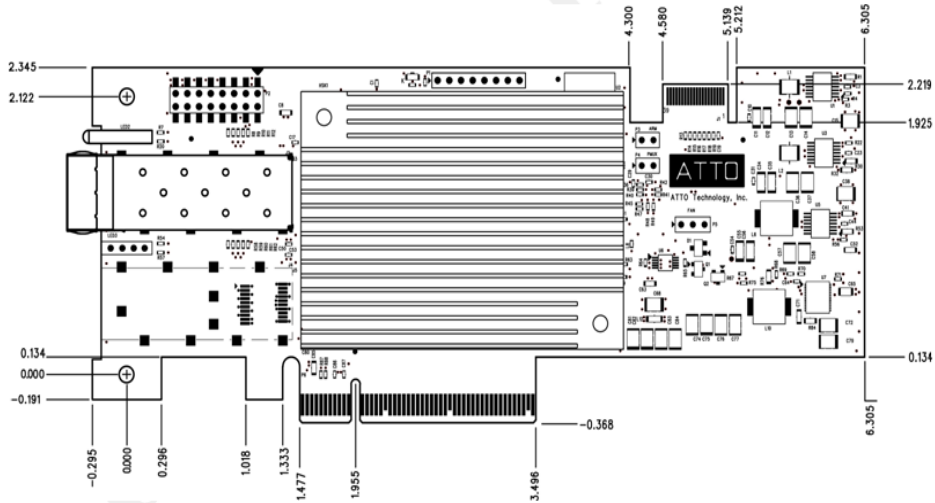

Exhibit 9 FC-84EN

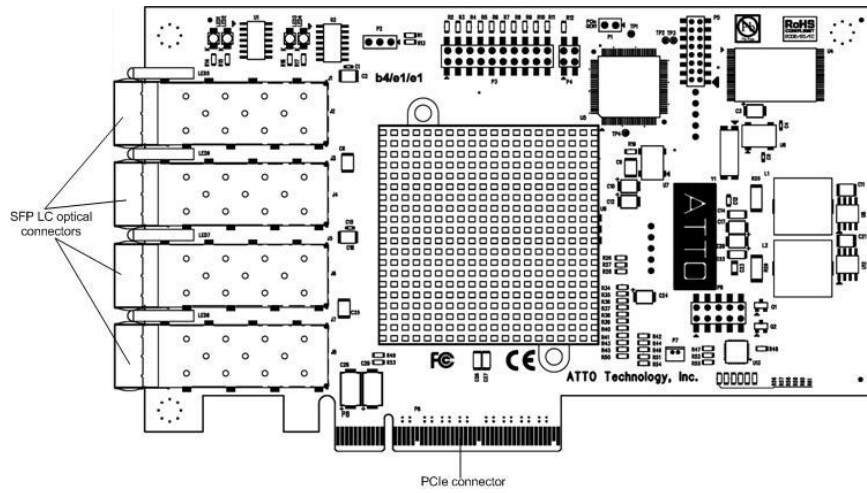
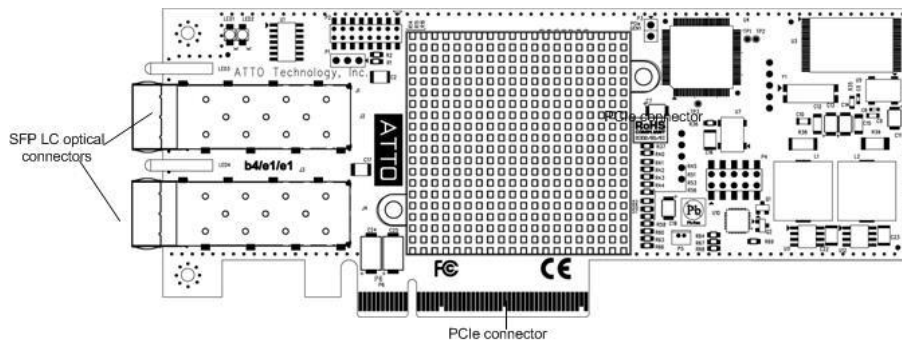

Exhibit 10 FC-82EN



4 Updating Hardware Flash, Drivers

Your Celerity FC host adapter is shipped with the latest flash and drivers but these may need to be updated as new versions become available. Visit the ATTO website, www.atto.com, to download the latest drivers and flash bundle.

Updating flash

Hardware flash memory may need to be updated as new versions become available.

1. Download and install the most recent version of the Configuration Tool from the ATTO website. Refer to [Updating the ATTO Configuration Tool](#).
2. Download the proper flash bundle (adapter specific) from the ATTO website.
 - a. Go to www.atto.com
 - b. Put cursor over Support and click on Downloads.
 - c. Register or log in if previously registered.
 - d. Click on Fibre Channel Host Adapters in the left dialog.
 - e. Navigate to your HBA model in the right dialog and click on it.
 - f. Scroll down to and click the desired flash bundle depending on the operating system.
 - g. A download window appears. Choose Save.
 - h. After the download has completed, process the downloaded file:
 - On macOS, mount the .dmg file.
 - On Windows, extract the .zip file.
 - On Linux, expand the .tgz file.
3. Launch the Configuration Tool.
 - On FreeBSD, use the atflash CLI tool
4. In the Device window, select the adapter that needs to be updated.
5. In the Flash window, click on the Browse button to find the flash bundle that you previously downloaded and extracted to your desktop.
6. Click Update to update your flash ROM.
7. Repeat for any additional adapters installed in the machine.
8. Reboot your system for the changes to take effect.

Updating drivers

Update drivers by downloading the latest driver software from the ATTO Technology website.

1. Go to www.atto.com
2. Put cursor over Support and click on Downloads.
3. Register or log in if previously registered.
4. Click on Fibre Channel Host Adapters in the left dialog.

5. Navigate to your HBA model in the right dialog and click it.
6. Scroll down to and click the desired driver depending on the operating system.
7. A download window appears. Choose Save.
8. After the download has completed, process the downloaded file:
 - On macOS, expand the .tgz file, then double click on the installer icon.
 - On Windows, run the downloaded .exe file.
 - On Linux, expand the .tgz file, then run the install.sh installation script.
9. Follow the instructions for installing the drivers.
 - On FreeBSD, expand the .txz file, then run the install.sh installation script.

Updating the ATTO Configuration Tool

If you want the latest version of the ATTO Configuration Tool, download it from the ATTO website.

1. Go to www.atto.com.
2. Put cursor over Support and click on Downloads.
3. Register or log in if previously registered.
4. Click on Fibre Channel Host Adapters in the left dialog.
5. Navigate to your HBA model in the right dialog and click it.
6. Scroll down to and click the desired ATTO Configuration Tool depending on the operating system.
7. A download window appears. Choose Save.
8. After the download has completed, process the downloaded file:
 - On macOS, mount the .dmg file, then double click on the installer icon located in the new volume.
 - On Windows, run the downloaded .exe file.
 - On Linux, expand the .tgz file, then run the install.sh installation script.
 - On FreeBSD, expand the .txz file, then run the install.sh installation script.
9. Follow the instructions for installing the application.
10. To use the tool, refer to the ATTO Utilities Installation and Operation Manual which may be downloaded from the ATTO website.
 - a. Go to www.atto.com.
 - b. Click on downloads.
 - c. Register or log in if previously registered.

- d. Click on Fibre Channel Host Adapters in the left dialog.
- e. Navigate to your HBA model in the right dialog and click it.

- f. Click the Utility Manual (.pdf) link to save/open the document.

5 Troubleshooting

This chapter contains solutions for the most common problems you might encounter. If you need additional assistance, please refer to the ATTO Technology website, www.atto.com, or contact an authorized ATTO Technology representative.

General suggestions

- Check each cable connection on every device.
- Verify all cables are in proper working condition. Loose or broken cables are often the cause of errors or problems.
- Check that Fibre Channel devices are plugged into an AC outlet and are turned on before you add power to your computer.
- For FC-164E only, if at boot up the port LED's blink from top to bottom, that indicates the card is not detecting sufficient power. The card may not operate or be seen by the system. Power down the system and install the appropriate external power cable supplied with the host bus adapter. Reboot once the cable is attached from the card to the power source.

macOS

-  **Note** *All Celerity FC models support macOS except 164E.*
1. Download the ATTO ConfigTool from the ATTO website. Refer to the ATTO Utilities manual for additional information on using this tool.
 2. If the adapter does not appear in the Device Listing, make sure it is properly seated in the PCI slot.
 - a. Remove power from the PC.
 - b. Remove the case.
 - c. Check the PCI slot.
 - d. Replace the case.
 - e. Apply power.
 3. Verify the driver is loaded.
 - a. Click on the adapter name in the Device Listing to view the Basic Info screen.
 - b. If the Driver Information section indicates Unknown: driver not loaded, reinstall the driver. Refer to [Updating Hardware Flash, Drivers](#).
 - c. If reinstalling the driver does not fix the problem, contact an authorized ATTO representative.
 4. Reset the NVRAM for all channels to defaults and reboot. If the problem persists, contact an authorized ATTO representative.

 **Note** *If the Celerity adapter is properly seated and devices are still not accessible, contact an authorized ATTO representative.*

 **Note** *When calling ATTO Technical Support, please have a printout of the IOreg listing and output from the Apple System Profiler available*

3. Verify the driver is loaded.

Windows

- If the card has been recently re-flashed, a new Windows driver must be installed. Follow the procedure in [Updating Hardware Flash, Drivers](#).
 - All of the external devices connected to the host adapter should be identified. If they do not appear in the Device Manager, the external devices or connection may not be working properly.
 - For Intel-based PCs, check the computer CMOS setup and verify that the PCI slots are configured correctly.
 - Procedures vary greatly; refer to the manual supplied with your system or call the computer supplier for configuration assistance.
 - Windows to OS are Plug-n-Play operating systems: be sure your computer's BIOS is set accordingly.
 - If these do not solve the problem, re-flash the host adapter and re-install the Windows driver. See [Updating Hardware Flash, Drivers](#).
- If the devices connected to the Celerity FC host adapter are not accessible:
1. Click on the Start button
 2. Click Control Panel. (In XP, 2000 and 2003, click Settings then Control Panel.)
 3. Double click on Administrative Tools.
 4. Double click on Computer Management.
 5. Select Device Manager.
- If the Celerity FC host adapter does not appear under the SCSI and RAID controllers, remove power from the PC, open the case, and check that the Celerity FC adapter is properly seated in the PCI slot. Replace the

- case and apply power.
- If the adapter has been identified but there is an exclamation point (!) on the listing, right click on the listing and select Uninstall.

6. Reload the driver (see Updating Hardware Flash, Drivers).
7. Reboot the system and repeat the installation process.
8. If problems persist, contact your authorized ATTO Technology representative

Linux

1. Verify the celerityfc driver is loaded with the lsmod command. If lsmod does not show the driver, refer to the installation instructions to install and load the driver in [Updating Hardware Flash, Drivers](#).
2. Check the system log with the command dmesg. The celerityfc driver creates status messages during initialization. Make sure that all installed cards are properly detected and initialized.

3. Examine the contents of the file(s) /proc/scsi/celerityfc/X, where X is the adapter's host number. This file contains details such as link status, connection speed and discovered devices.



Note

Advanced users only. Modify the driver makefile to enable debugging information. Upon loading, the celerityfc driver displays detailed debugging information which may help troubleshoot the problem.

VMware

1. After driver installation, you must reboot the host. Once the host is back online, go to Storage and create VMFS datastore. If storage does not appear, perform a rescan

using the VMware Storage option. If your storage does not present itself, thereafter, please contact your SAN administrator.

FreeBSD

1. Verify the clrty16fc.ko driver is loaded with the kldstat command. If kldstat does not show the driver, refer to the installation instructions to install and load the driver in [Updating Hardware Flash, Drivers](#).
2. Check the system log with the command dmesg. The clrty16fc.ko driver creates status messages during

initialization. Make sure all installed cards are properly detected and initialized.



Note

Advanced users only. Modify the driver makefile to enable debugging information. Upon loading, the clrty16fc.ko driver displays detailed debugging information which may help troubleshoot the problem.

illumos

1. Verify the clrty16fc.ko driver is loaded with the modinfo command. If modinfo does not show the driver, refer to the installation instructions to install and load the driver in [Installing Drivers](#).
2. Check the system log with the command dmesg. The clrty16fc driver creates status messages during initialization. Make sure all installed cards are properly detected and initialized.



Note

Advanced users only. Refer to the driver README.txt included in the downloaded driver package for information on how to enable debugging information in the clrty16fc.conf located in /kernel/drv. Upon loading, the clrty16fc driver displays detailed debugging information which may help troubleshoot the problem.

Supplemental Guide for VMware ESX/ESXi

The following information should be used by advanced users only. Please consult with our Technical Support Department before applying any of the following information.

Driver Configuration

Use the commands documented below to query and configure the ATTO adapter driver parameters. In the

examples that follow, <driver name> should be replaced with the ATTO driver name.

To obtain a list of available driver parameters:

For ESXi 5.x:

```
# esxcli system module parameters list -m=<driver-name>
```

To list the driver parameters that have been set:

For ESXi 5.x:

```
# esxcli system module parameters list -m=<driver-name>
```

To set a driver parameter:

For ESXi 5.x:

```
# esxcli system module parameters set -m=<driver-name> -  
p param=value
```

The driver parameter settings are persistent across system reboots. However, the changes will not take affect until the system is rebooted.

The following table lists the configurable parameters along with a brief description. Supported driver abbreviations are: A - All drivers, C - celerityfc, celerity8fc, E - esashba, esas2hba.

PARAMETER	DESCRIPTION	Driver Support
atto_log_mask	Defines the log mask for sending ATTO driver information to the system log. Default is 0 (none).	A
atto_max_sectors	Maximum number of disk sectors in a single data transfer. Default is 65535 (largest possible value).	A
can_queue	Maximum number of commands per adapter channel. Default is 128.	A
change_notification	Enable notifying the OS of the arrival and departure of target devices. Default is 1 (on).	A
cmd_per_lun	Maximum number of commands per LUN. Default is 16.	A
cmd_retry_count	Maximum number of retries allowed for a command. Default is 20.	A
event_log_mask	A bit mask of events to report to the system log. Default is 0x00000001 (critical events only).	A
fab_alternate_exchanges	Causes the chip to alternate between to exchanges when it runs out of credits on a fabric. This may improve performance in multiple initiator/target environments. Default is 0 (off).	C
heap_initial	Initial heap size allocated for the driver.	A
heap_max	Maximum attainable heap size of the driver.	A
io_time_out	Time (in seconds) before an I/O command is timed out by the driver. Set to 0 for no timeout. Default is 30.	A
max_logins	Defines the maximum number of ports that can be logged in at once. Default is 256.	C
num_erq	Exchange Request Queue entries. In general, one ERQ entry is required for each SEST entry. Default is 256.	C
num_imq	Incoming Message Queue entries. These are used to report completion of I/O requests and to notify the host driver of certain other kinds of events detected by the hardware. Default is 256.	C
num_sas_addr	Number of SAS addresses to assign to the adapter's PHYs. Addresses are assigned sequentially from the base address. Valid settings are 1, 2, 4, 8. Default is 1.	E

num_sest	Number of entries in the SCSI Exchange State Table. One of these structures is used per active exchance. Default is 256.	C
num_sg_lists	Number of SGL pages. Default is 256.	A
num_targets	Maximum number of target devices. Default is 256.	E
old_device_reset	Use the old device reset method. Default is 0 (use new method).	A
port_retry_count	Maximum number of retries allowed for a port which is logged out. Default 0 (use NVRAM setting).	C
private_els_timeout	Timeout (in seconds) for ELS commands when on a private loop. Default is 2.	C
quick_init	Enabled quick link initialization. Default is 1 (enabled).	C
sg_tablesize	Maximum number of entries in a scatter/gather table. A value of 255 means that the S/G table be any size. Default is 255.	A
sgl_page_size	Scatter/Gather List page size in number of S/G entries. Default is 128.	A
speed_override	Override the NVRAM link speed setting. 0 for auto speed negotiation, 2 for 2Gb, 4 for 4Gb or 8 for 8Gb. Other values will cause the use of NVRAM setting. Default is -1 (use NVRAM setting)	C
topology_override	Override the NVRAM topology setting. 0 for loop, 1 for PTP, 2 for loop preferred, 3 for PTP preferred. Other values will cause the use of NVRAM setting. Default is -1 (use NVRAM setting).	C
use_multiqueue	Distributes I/O across queues based on CPU affinity. This may result in reduced CPU cost per I/O. Default is 0 (disabled).	C
use_tm_completions	Wait for task management commands to complete before returning from handler. Default is 1 (enabled).	A
use_transport_layer	Attached to the SCSI transport layer. Default is 1 (enabled).	A

Adapter Management

On VMware ESX/ESXi you can identify and manage ATTO adapters using the VMware vSphere Client, or the Service Console. On ESXi, the Service Console is referred to as Local Tech Support Mode.

vSphere Client

With VMware vSphere Client, you can identify ATTO adapters on a VMware ESX/ESXi system, and view the attached storage devices.

1. Start vSphere Client from your local workstation and select the host containing one or more ATTO adapters.
2. Click the Configuration tab, and then select Storage Adapters under Hardware in the left pane.

3. A list of all storage adapters in the system is displayed. The Model, Identifier (WWN or SAS address) and Targets are shown for each adapter channel.

Service Console

Using the Service Console, information about each adapter channel can be found in the /proc/scsi filesystem, under /proc/scsi/<driver name>.

To view details on a specific adapter channel, run the following command:

```
# cat /proc/scsi/<driver name>/<channel>
```

This command displays the following information:

"Adapter type

"Driver, BIOS and Firmware versions

"Driver Parameters

"Adapter Model and Identifier (WWN or SAS address)

"Virtual Port Information

"Discovered Targets

"Driver Statistics

A sample output is shown below:

~ # cat /proc/scsi/celerity8fc/6

ATTO Celerity 8GB Fibre Channel Adapter

Driver version 1.31

BIOS version 07/28/2010

Firmware version 06.01.00

Copyright 2001-2010

<http://www.atto.com>

Driver Parameters:

quick_init=1, max_logins=256, speed_override=-1,
num_srst=256, num_imq=256, num_erq=256,
private_els_timeout=2, port_retry_count=0,
topology_override=-1, fab_alternate_exchanges=0,
sgl_page_size=128, event_log_mask=0x00000001,
num_sg_lists=1024, cmd_per_lun=16, can_queue=128,
sg_tablesize=255, atto_max_sectors=65535,

cmd_retry_count=20, io_time_out=30,
change_notification=1, old_device_reset=0, t10_dif=0

Adapter Information:

Model: ATTO Celerity FC-82EN

WWNN: 20000010:8601dfb0

WWPN: 21000010:8601dfb0

Link down

Virtual Port Information (NPIV): Max VPorts:16 Max
VLogins:32

Discovered Ports:

#	TargID	PortWWN	PortId	IT
---	--------	---------	--------	----

None

Statistics:

Time elapsed (ms) : 95353655

Commands completed : 0

Outstanding commands : 0

Max outstanding commands: 0

Virtual Ports (NPIV)

N_Port ID Virtualization (NPIV) is an extension to the Fibre Channel industry standard. NPIV allows a single, physical adapter port to function as multiple virtual ports (VPorts), each having a unique Fibre Channel World-Wide-Name in the SAN. This allows a Storage Administrator to follow SAN best practices, such as zoning and masking, to control LUN access on a per-VPort basis.

Support for NPIV is included in the ATTO 8Gb and 16Gb Celerity drivers available for both Windows and VMware ESX/ESXi. The following sub-sections contain an overview of the NPIV functionality provided on each platform.

Windows



Note *NPIV support for Windows is currently limited to Windows Server 2008 R2 and Hyper-V R2.*

The 8Gb, 16Gb and 32Gb Celerity drivers for Windows provide NPIV support compatible with Microsoft's Hyper-V virtualization platform. Each physical port on the adapter is capable of supporting up to eight virtual ports. NPIV functionality is disabled by default and must be enabled via the Windows registry (refer to the "Registry Settings" section of the readme.html file in the ATTO install directory for details on modifying HBA registry parameters). The following registry values are applicable to NPIV:

Name	Default Value	Range	Usage
NpivEnable	0	0, non-0	A non-zero value enables the NPIV functionality in the driver. A zero value disables NPIV.
MaxNpivVPorts	8	1-8	Sets the maximum number of virtual ports that can be created on each physical port in the adapter. Setting this parameter to a value outside the stated range will cause the driver to revert to the default value (note that zero is not a valid value).
TargetMode	0	0, non-0	A non-zero value enables the Target Mode functionality in the driver. This parameter must be either undefined or set to zero for the NPIV functionality to be enabled.

The Default Value is the value assigned to the parameter when it is not explicitly defined in the registry

As mentioned above, NPIV functionality is not compatible with the existing Target Mode capabilities of the Windows driver. As such, Target Mode must be disabled in order for NPIV to be successfully enabled. Attempting to enable both Target Mode and NPIV will enable Target Mode, but disable NPIV, causing a Warning message (Event ID 32818) to be posted to the Windows Event Log.

For Hyper-V, virtual ports need to be explicitly created before they can be used by a virtual machine. The creation and management of virtual ports is a function of the ATTO Configuration Tool. Please refer to the ATTO Utilities Installation and Operation Manual for details on using the ConfigTool to manage virtual ports.

For additional information about utilizing NPIV in a Hyper-V environment refer to TechNet topic "Configuring a SAN Environment for VMM" (<http://technet.microsoft.com/en-us/library/cc764269.aspx>).

VMware ESX/EXi

The 8Gb and 16Gb Celerity drivers for VMware ESX/ESXi 4.x and VMware ESXi 5.x provide NPIV support by default (the functionality does not have to

be explicitly enabled). However, there are four driver parameters that affect the performance and behavior of the NPIV feature, they are as follows:

max_npiv_logins	The maximum number of target ports that can be logged into a virtual port. Default is 32; maximum is 256.
max_npiv_vports	The maximum number of virtual ports for an adapter channel. The default is 16; maximum is 64
npiv_disc_wait_time	The time period (in ms) that the driver waits for discovery to complete after creating a virtual port. Default is 10000.
npiv_init_retries	The number of times to attempt to initialize a virtual port before giving up. Default is 10.

Information about the VPorts is shown in the Driver info file on the Service Console. Refer to the Supplemental Guide for VMware ESX/ESXi in this chapter for details on viewing or modifying the above values.

Virtual ports are created by the kernel when an associated VM is started, and deleted when the VM is stopped. Active virtual ports will appear as additional Virtual Adapters in the vSphere client.

For additional NPIV configuration details, please consult the VMware Fibre Channel SAN Configuration Guide (http://www.vmware.com/pdf/vsphere4/r41/vsp_41_san_cfg.pdf).

Appendix A Glossary

Some terms used in the Fibre Channel industry are defined below. More information is available through the ATTO Technology website (www.atto.com), the Fibre Channel Industry Association (www.fibrechannel.com), Cern (www.cern.ch), the Storage Area Networking Industry Association (www.snia.org), and the Fibre Channel Consortium (www.iol.unh.edu/consortiums, click on FC).

Term	Definition
ANSI	American National Standards Institute
arbitrate	process of selecting one L_Port from a collection of ports which ask for use of the arbitrated loop at the same time
arbitrated loop	a loop topology (FC-AL) in which two or more ports are interconnected, but only two ports can communicate at one time; low-cost solution which may or may not use hubs and switches
auto negotiation	hardware senses and automatically responds depending on configuration
BER	Bit Error Rate: a measure of transmission accuracy; the ratio of bits received in error to bits sent
bit	smallest unit of data a computer can process: a single binary digit with a value of either 0 or 1
bus	a collection of unbroken signal lines used to transmit information from one part of a computer system to another; taps on the lines connect devices to the bus
byte	an ordered set of 8 bits
channel	a point-to-point link which transports data from one point to another
CPU	Central Processing Unit: the portion of the computer that actually performs computations
CRC	Cyclic Redundancy Check: an error-correcting code which calculates a numeric value for received and transmitted data; if no error has occurred during transmission, the CRC for both received and transmitted data should be the same
destination address	a value in the frame header of each frame which identifies the port in the node where the frame is being sent
device driver	a program that allows a microprocessor to direct the operation of a peripheral device
DMA	Direct Memory Access: a way to move data from a storage device directly to RAM without using the CPU's resources
DMA bus master	allows a peripheral to control the flow of data to and from system memory by block as opposed to allowing the processor to control the data by bytes (PIO or programmed I/O)
fabric	a Fibre Channel switch of two or more Fibre Channel switches interconnected to physically transmit data between any two N_Ports on the switch or switches
FC	Fibre Channel

F_port	a port in the Fibre Channel fabric where a N_port may attach
FL_port	a port in the Fibre Channel fabric where a NL_port may attach in an arbitrated loop
frame	an indivisible unit for transfer of information in Fibre Channel
frame header	the first field in the frame containing the address and other control information about the frame
full-duplex	a communication protocol which allows transmission in both directions at the same time
half duplex	a communication protocol which allows transmission in both directions, but only one direction at a time
host	a processor, usually a CPU and memory, which communicates with devices over an interface
initiator device	a component which originates a command
L_port	a port in an arbitrated loop, either a NL_port or a FL_port
LED	Light-emitting diode: a type of diode that emits light when current passes through it; visible LEDs are used as indicator lights on all sorts of electronic devices
LUN	Logical Unit Number: an identifier for a logical unit (0-7)
multi-mode fiber	an optical fiber which can carry several beams of light at once
N_port	a port attached to a node used with point to point or fabric configurations
NL_port	a port attached to a node in Fibre Channel arbitrated loop or fabric loop configuration
originator	an initiating device; a component which originates a command
parity checking	a method which verifies the accuracy of data transmitted over the SCSI bus by adding one bit in the transfer to make the sum of all the bits either odd or even (for odd or even parity); an error message occurs if the sum is not correct
PCI	Peripheral Component Interconnect. Allows peripherals to be connected directly to computer memory, bypassing the slower ISA and EISA busses
point-to-point	a topology where two ports communicate
port	an access point in a device: see N_port, NL_port, etc.
port address	also port number; the address, assigned by the PCI bus, through which commands are sent to a host adapter board
port number	see port address
receiver	the ultimate destination of data transmission; a terminal device

SAS	Serial Attached SCSI: a serial SCSI bus technology and point to point architecture for connecting host bus adapters to storage devices
SATA	Serial AT Attachment: a serial ATA bus technology and point to point architecture for connecting host bus adapters to storage devices
scatter/gather	a device driver feature which allows the host adapter to modify a transfer data pointer so that a single host adapter can access many segments of memory, minimizing interrupts and transfer overhead
SCSI	Small Computer Systems Interface: a processor-independent standard for system-level interface between a computer and intelligent devices including hard disks, floppy disks, -ROM, printers, scanners, etc.
single-mode fiber	an optical fiber with a small core which supports one wavelength (ray of light); the core radius is nearly equal to the wavelength of the source
SNMP	Simple Network Management Protocol: a standard for monitoring network-attached devices
topology	logical layout of the parts of a computer system or network and their interconnections
transceiver	a transmitter/receiver module
transfer rate	the rate at which bytes or bits are transferred, as in megabytes or gigabits per second

Appendix B Standards, Compliances: 16Gb adapters

The Technical Specification sheet for each Celerity FC host adapter lists certifications for that model. Models covered by this page include the Celerity FC-164E, FC-162E and FC-161E.

FCC standards: radio and television interference



This equipment has been tested and found to comply with the limits for a Class B digital device, pursuant to Part 15 of the FCC Rules. These limits are designed to provide reasonable protection against harmful interference in a residential installation. This equipment generates, uses, and can radiate radio frequency energy and, if not installed and used in accordance with the instruction manual, may cause interference to radio communications. However, there is no guarantee that interference will not occur in a particular installation. If this equipment does cause interference to radio or television reception, which can be determined by turning the equipment off and on, the user is encouraged to try to correct the interference by one or more of the following measures:

- Reorient or relocate the receiving antenna
- Increase the separation between the equipment and receiver
- Connect the equipment into an outlet on a circuit different from that to which the receiver is connected
- Consult the dealer or an experienced radio/TV technician for help

Canadian standards



This Class A digital apparatus complies with Canadian ICES-003.

Cet appareil numérique de la classe A est conforme à la norme NMB-003 du Canada.

European standards



Declaration of Conformity

This following statement applies to the Celerity FC host adapter.

This device has been tested in the basic operating configuration and found to be compliant with the following European Union standards: Application of Council Directive: 89/336/EEC

Standard(s) to which conformity is declared: EN55024:2002; EN55022:2002 CLASS B.

This Declaration will only be valid when this product is used in conjunction with other CE approved devices and when the entire system is tested to the applicable CE standards and found to be compliant.



Some ATTO Celerity cards comply with Directive 2011/65/EU on the Restriction of the Use of Hazardous Substances in Electrical and Electronic Equipment (RoHS). Contact your ATTO representative regarding RoHS compliant products.

Appendix C Standards, Compliances: 8Gb adapters

The Technical Specification sheet for each Celerity FC host adapter lists certifications for that model. Models covered by this page include the Celerity FC-84EN, FC-82EN and FC-81EN.

FCC standards: radio and television interference



This equipment has been tested and found to comply with the limits for a Class B digital device, pursuant to Part 15 of the FCC Rules. These limits are designed to provide reasonable protection against harmful interference in a residential installation. This equipment generates, uses, and can radiate radio frequency energy and, if not installed and used in accordance with the instruction manual, may cause interference to radio communications. However, there is no guarantee that interference will not occur in a particular installation. If this equipment does cause interference to radio or television reception, which can be determined by turning the equipment off and on, the user is encouraged to try to correct the interference by one or more of the following measures:

- Reorient or relocate the receiving antenna
- Increase the separation between the equipment and receiver
- Connect the equipment into an outlet on a circuit different from that to which the receiver is connected
- Consult the dealer or an experienced radio/TV technician for help

Canadian standards



This Class A digital apparatus complies with Canadian ICES-003.

Cet appareil numérique de la classe A est conforme à la norme NMB-003 du Canada.

European standards



Declaration of Conformity

This following statement applies to the Celerity FC host adapter.

This device has been tested in the basic operating configuration and found to be compliant with the following European Union standards: Application of Council Directive: 89/336/EEC

Standard(s) to which conformity is declared: EN55024:2002; EN55022:2002 CLASS B (82EN & 81EN). EN55022:2002 CLASS A (84EN).

This Declaration will only be valid when this product is used in conjunction with other CE approved devices and when the entire system is tested to the applicable CE standards and found to be compliant.



Some ATTO Celerity cards comply with Directive 2002/95/EC on the Restriction of the Use of Hazardous Substances in Electrical and Electronic Equipment (RoHS). Contact your ATTO representative regarding RoHS compliant products.

Appendix F Safety, Warranty

All ATTO host adapter products have been tested to meet applicable safety standards when operated in proper electrical and thermal environments.

Safety

Please review the specifications for your specific host adapter before installing and operating it in any computer system to ensure compatibility.

Installation

Before installing an ATTO host adapter product into your computer system, unplug the computer from its electrical power source and allow adequate time for electrical discharge and the internal components to cool down before removing the computer system cover. This will decrease the risk of personal injury from electrical shock or touching the hot surface of an electrical component.

Once an ATTO host adapter is installed in a computer system, the computer cover must be reinstalled properly before turning the computer system back on.

Operation

ATTO host adapters require adequate cooling to function properly. If you have any questions as to the airflow provided by your computer system, please refer to your computer system manual or contact your computer system manufacturer.

To facilitate proper air circulation, ATTO host adapters should never be operated in a computer system without the cover installed or with an inoperable fan as this may cause safety or thermal problems which could damage the ATTO host adapter and void the warranty.

ATTO Technology, Inc. limited warranty

ATTO Technology, Inc. ("ATTO") warrants to the original purchaser of this product ("Product") that the Product is free from defects in material and workmanship for the term described for this specific Product on ATTO's website (www.atto.com). ATTO's liability shall be limited to replacing or repairing any defective product at ATTO's option. There is no charge for parts or labor if ATTO determines that this product is defective.

PRODUCTS WHICH HAVE BEEN SUBJECT TO ABUSE, MISUSE, ALTERATION, NEGLIGENCE, OR THOSE PRODUCTS THAT HAVE BEEN SERVICED, REPAIRED OR INSTALLED BY UNAUTHORIZED PERSONNEL WILL NOT BE COVERED UNDER THIS WARRANTY. DAMAGE RESULTING FROM INCORRECT CONNECTION OR AN INAPPROPRIATE APPLICATION OF THIS PRODUCT SHALL NOT BE THE RESPONSIBILITY OF ATTO. LIABILITY UNDER THIS LIMITED WARRANTY IS LIMITED TO ATTO PRODUCT(S). DAMAGE TO OTHER EQUIPMENT CONNECTED TO ATTO PRODUCT(S) IS THE CUSTOMER'S RESPONSIBILITY. THIS LIMITED WARRANTY IS MADE IN LIEU OF ANY OTHER WARRANTIES, EXPRESS OR IMPLIED. ATTO DISCLAIMS ANY IMPLIED WARRANTIES OF MERCHANTABILITY OR FITNESS FOR A PARTICULAR PURPOSE. TO THE EXTENT IMPLIED WARRANTIES CANNOT BE EXCLUDED, SUCH IMPLIED WARRANTIES ARE LIMITED IN DURATION TO THE EXPRESS WARRANTY PERIOD APPLICABLE TO THE PRODUCT. BECAUSE SOME STATES OR JURISDICTIONS DO NOT ALLOW LIMITATIONS ON THE DURATION OF IMPLIED WARRANTIES, THE ABOVE MAY NOT BE APPLICABLE. ATTO'S RESPONSIBILITY TO REPAIR OR REPLACE A DEFECTIVE PRODUCT IS THE SOLE AND EXCLUSIVE REMEDY PROVIDED TO THE CUSTOMER FOR BREACH OF THIS WARRANTY.

ATTO IS NOT RESPONSIBLE FOR DAMAGE TO OR LOSS OF ANY DATA, PROGRAMS OR ANY MEDIA. THE PRODUCTS ARE NOT INTENDED FOR USE IN: (I) MEDICAL DEVICES OR THE MEDICAL FIELD; OR (II) USE IN RUGGED APPLICATIONS.

ATTO IS NOT LIABLE FOR ANY INDIRECT, SPECIAL, INCIDENTAL, OR CONSEQUENTIAL DAMAGES, IRRESPECTIVE OF WHETHER ATTO HAS BEEN ADVISED OF THE POSSIBILITY OF SUCH DAMAGES. NO ATTO DEALER, AGENT OR EMPLOYEE IS AUTHORIZED TO MAKE ANY MODIFICATION, EXTENSION OR ADDITION TO THIS WARRANTY.

This warranty gives you specific legal rights, and you may also have other rights which vary from state to state.

